



Glenn Research Center

# **HIGH SPEED PERMANENT MAGNET SYNCHRONOUS MOTOR / GENERATOR DESIGN FOR FLYWHEEL APPLICATIONS**

Aleksandr Nagorny, Ph.D.  
National Research Council



Glenn Research Center

# Outline

- Introduction
- Selection of the Rated Point
- The major requirements for flywheel M/G in space applications
- Meeting design requirements
- M/G Main Materials Selection
- Lamination Thickness Selection
- Modeling tools
- M/G Preliminary Design Process
- Permanent Magnet Material Selection
- The RMxprt Analytical Design Output
- Armature Reaction and Demagnetization Calculation
- M/G 2D Finite Element Modeling
- M/G 3D Finite Element Modeling
- Concluding Observations and Recommendations
- References
- Acknowledgements



Glenn Research Center

## Introduction

- The motor / generator design is a part of work performed at NASA Glenn Research Center devoted to the development of flywheel modules for use in satellite energy storage and attitude control systems.
- The benefits of flywheel module as an energy storage device in spacecraft application compared to the chemical batteries are the following: higher energy and power densities, deeper depth of discharge, broader operating temperature range.
- Flywheel can be used as a source of momentum for attitude control, giving the opportunity to combine two satellite subsystems into one and reduce the overall volume and mass.

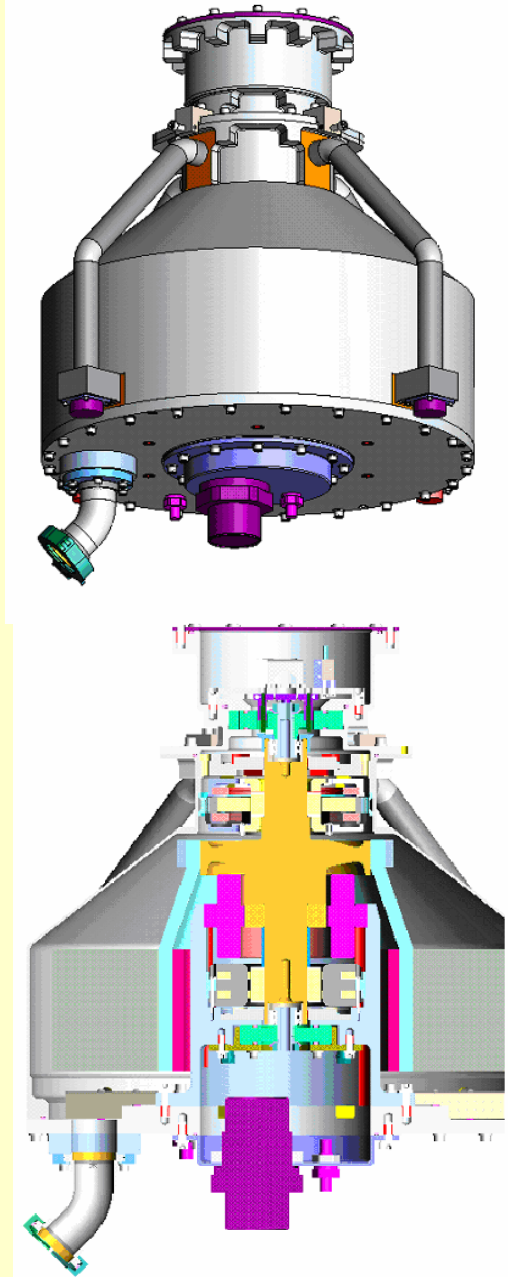



# Selection of the Rated Point

- Determination of the output power
- ✓ The output power determination is based on the load profiles during the load cycles.
- ✓ From  $t=0$  to  $t=60$  min it is a charge (motor mode), from  $t=60$  to  $t=90$  min it is a discharge (generator mode).

In each point the net torque of M/G is equal

$$T_{net} = T_{ES} + T_{AC}$$

Where  $T_{ES}$  is the torque component required for the energy storage, and  $T_{AC}$  is the component required for the attitude control.

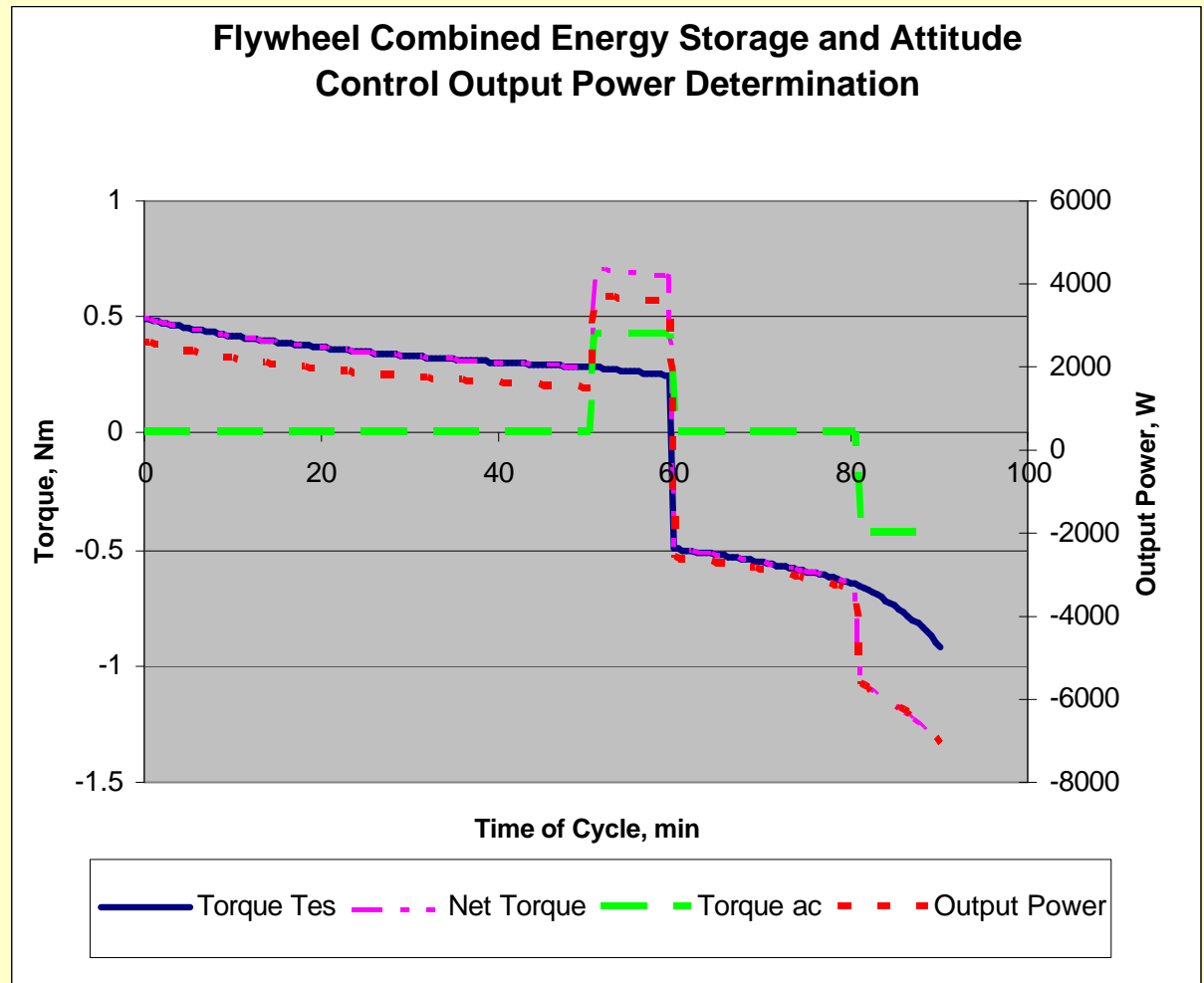



Glenn Research Center

## The major requirements for flywheel M/G in space applications

- Relatively high electrical frequency of voltages and currents
- High specific power
- High efficiency, low total losses
- Low THD at the back emf waveform
- Low cogging torque values
- Low rotor losses
- High thermal endurance, ability to operate in vacuum without intensive cooling



## Meeting design requirements

### High specific power:

- Right selection of the M/G configuration
- Application of high magnetic energy permanent magnet materials
- Application of high permeability core lamination materials

### High efficiency, low total losses:

- Choice of an AC permanent magnet synchronous machine with the zero fundamental frequency rotor magnetic and conductive losses
- Application of core lamination materials with low specific losses
- Application of thin diameter stranded wires for the stator armature conductors to reduce the high frequency skin effect losses



## Meeting design requirements (cont'd)

Low THD at the back emf waveform and low cogging torque value.

Could be achieved by the reducing the high frequency spatial mmf harmonics by the following methods:

- Make the magnet pole arcs short pitched
- Two layer short pitched stator winding
- Skewing of the stator core in axial direction
- Relatively large non-magnetic gap;
- Small value for slot opening to slot pitch ratio
- Special shape for the stator teeth (dummy slots)
- Lamination of permanent magnets in axial direction

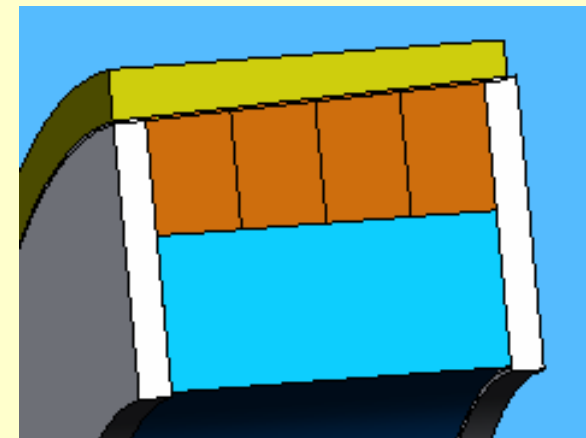
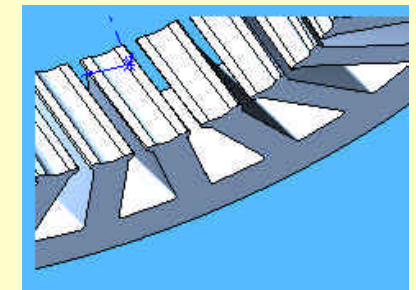
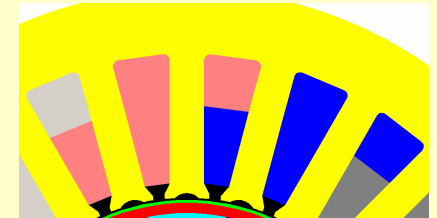
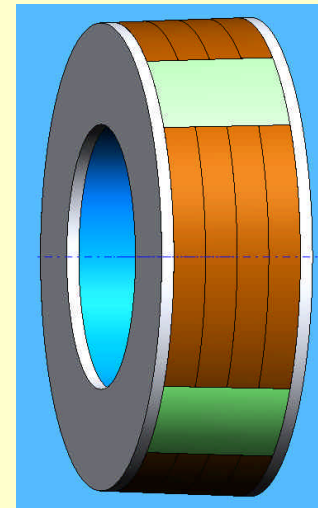



## Meeting design requirements (cont'd)

### Low value of the rotor losses:

- The main components of the rotor losses :
  - ✓ Back iron loss;
  - ✓ Eddy current loss in permanent magnet material;
  - ✓ M/G carbon fiber sleeve loss;
  - ✓ Windage loss.

The first three components of the rotor losses are caused by the high frequency spatial mmf harmonics. The measures to reduce them are the same as described on previous slide. The effective measure against the back iron losses is lamination of the back iron core.





## Meeting design requirements (cont'd)

### High thermal endurance:

- High thermal endurance can be achieved by using the appropriate materials for the stator and rotor parts:
  - ✓ Stator and rotor core lamination materials
  - ✓ Wire insulation
  - ✓ Slot insulation
  - ✓ Winding parts insulation
  - ✓ Motor leads insulation
  - ✓ Permanent magnet materials
  - ✓ Rotor carbon fiber composite.

For the current M/G design all the materials except carbon fiber composite have the rated temperature above 200 °C.



# M/G Main Materials Selection

## *Using of prospective materials*

The major motor materials that can affect the motor performance are the following

- core ferromagnetic materials
- permanent magnet materials
- magnet wires
- winding insulation

## *Core ferromagnetic materials*

- Two major characteristics of the core ferromagnetic materials can affect the motor performance
  - ✓ the maximum saturation flux density
  - ✓ specific losses



## Modeling tools

Ansoft Corporation RMxpert software is used for the preliminary motor design.

The advantages of the RMxpert software are the following:

- The ability to get an easy and fast response in a convenient form
- The output data can be easily exported to other Ansoft software (Maxwell 2D, Simplorer)
- The program can perform optimization of the input parameters



Glenn Research Center

## M/G Preliminary Design Process

The numerous design iterations were completed to meet the motor requirements in motor and generator mode. Different rotor configurations, permanent magnet and core materials and M/G geometry were optimized using the RMxprt parametric analysis mode.

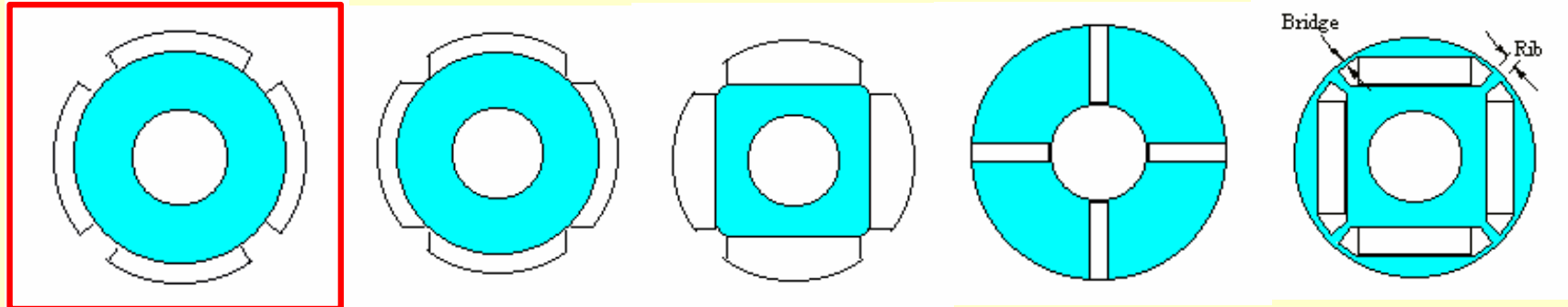

The highest level of the output power in a combination of relatively low back EMF THD level was obtained for the surface mounted arc shaped magnet configuration



# Permanent Magnet Material Selection

M/G Output Power in Generator Mode for different PM Materials

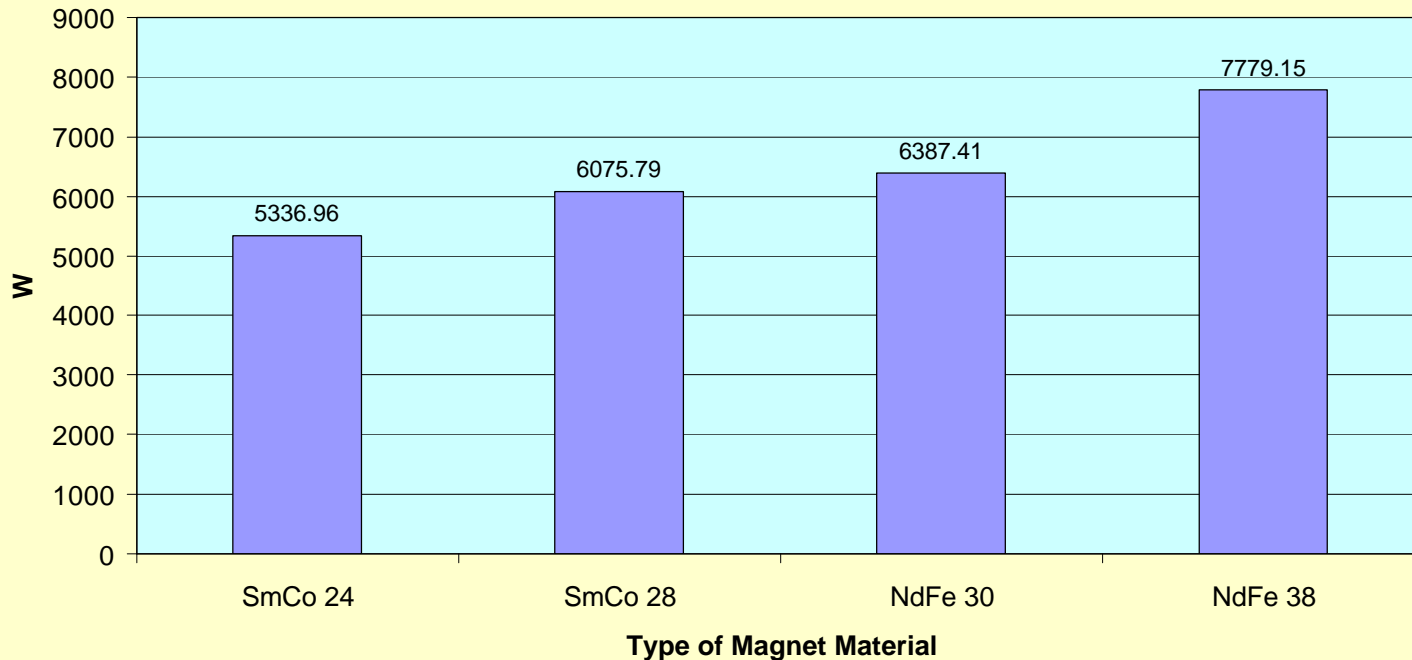

NdFe group has higher remanent magnetization and energy product.

SmCo has a better thermal characteristic.



## Lamination Thickness Selection

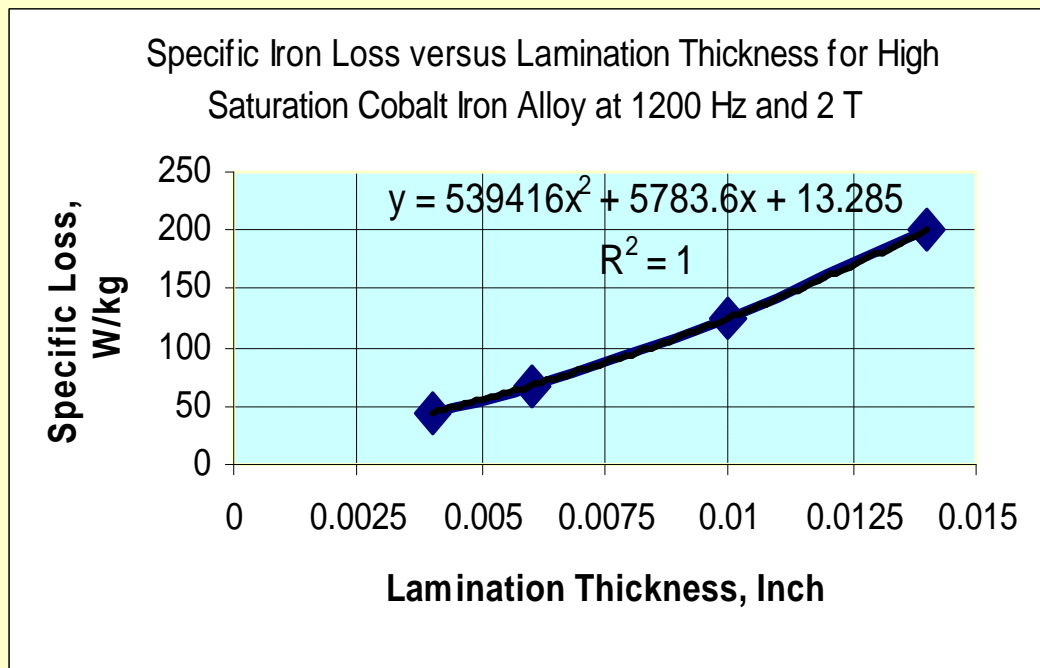

- At high frequencies (1.2 kHz) and high flux densities (2.0 T) the specific iron loss is proportional to the square of lamination thickness. For the reduction of the iron loss, the lamination thickness should have a low value (in our case 0.004”).



# The RMxprt Analytical Design Output

STATOR DATA	
Number of Stator Slots:	24
Outer Diameter of Stator (inch):	5.75
Inner Diameter of Stator (inch):	2.9
Length of Stator Core (inch):	0.728
Number of Conductors per Slot:	6

ROTOR DATA	
Non Magnetic Gap, inch	0.105
Inner Diameter (inch):	1.51
Length of Rotor (inch):	0.728
Max. Thickness of Magnet (inch):	0.27
Type of Magnet:	SmCo

M/G parameters at rated point	Motor Mode	Generator Mode
Rated Output Power (kW):	7.6	7.6
Rated Voltage (V):	61	61
Number of Poles:	4	4
Frequency (Hz):	1666.67	1666.67
Operating Temperature (C):	115	115
THD of Induced Voltage (%):	0.964	0.964
Cogging Torque (N.m):	0.016	0.015
Line Current RMS (A):	72.594	72.016
Efficiency (%):	98.168	98.164
Synchronous Speed (rpm):	50000	50000
Rated Torque (N.m):	1.452	1.482
Total Net Weight (lb):	7.55	7.55



Glenn Research Center

# The RMxprt Analytical Design Output (cont'd)

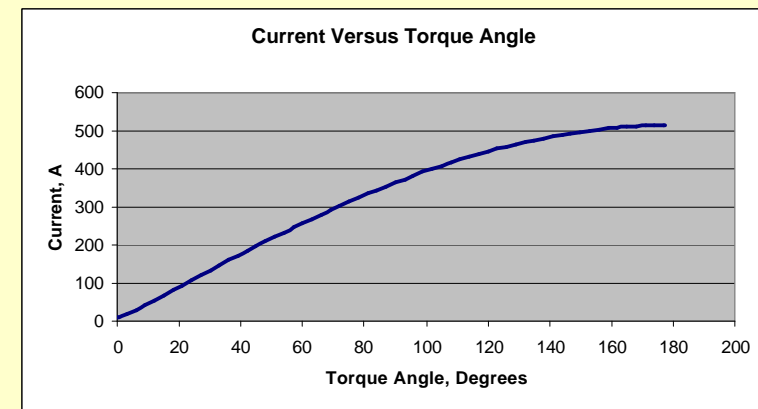
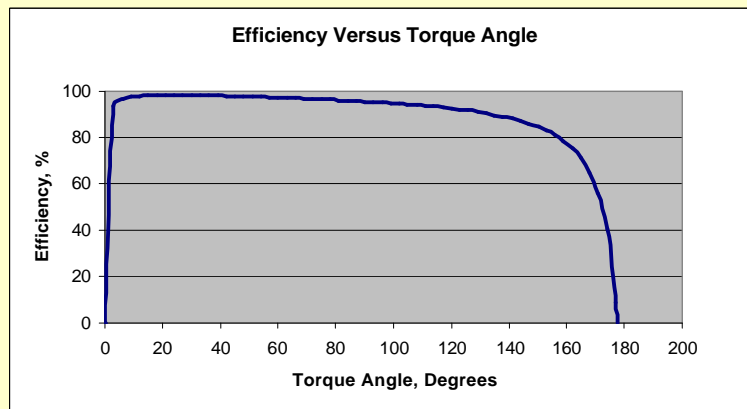
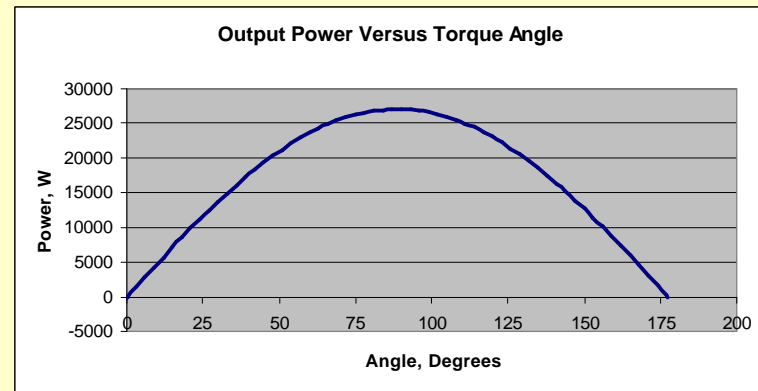
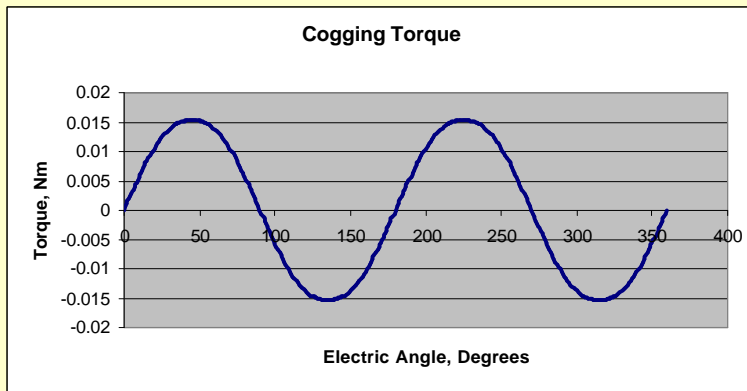





# The RMxprt Analytical Design Output vs FEA

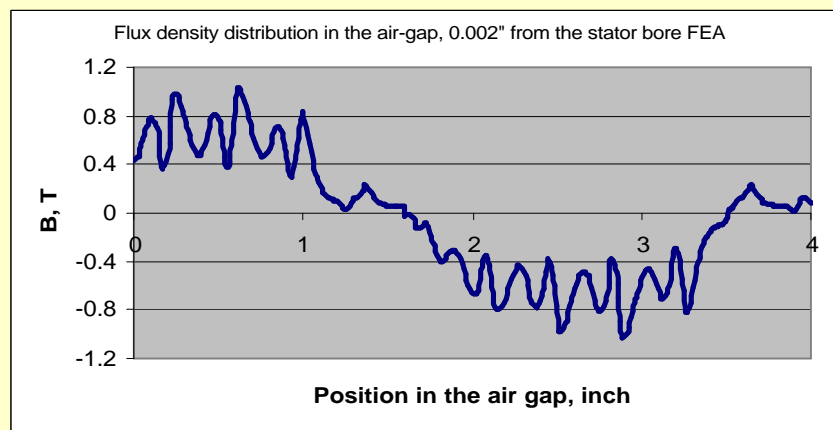
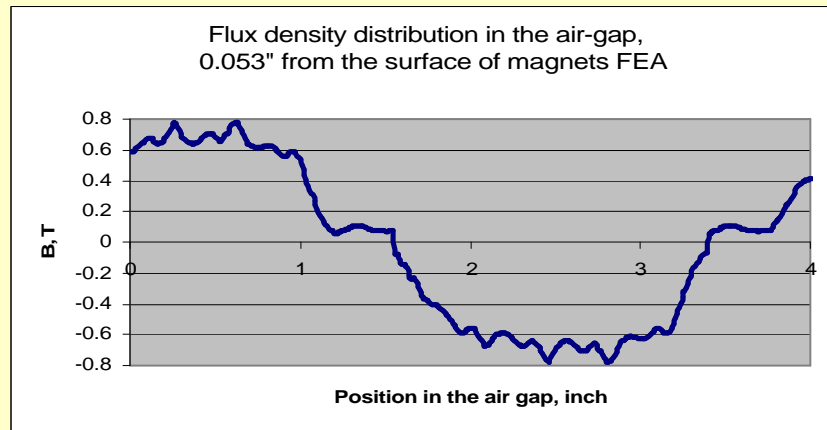
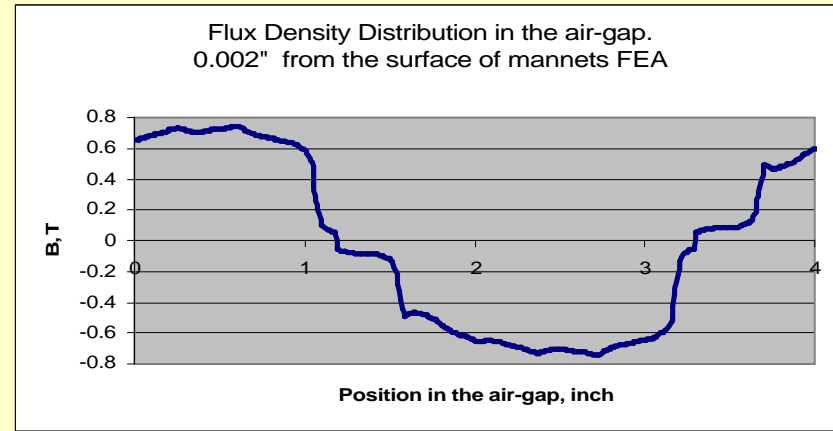
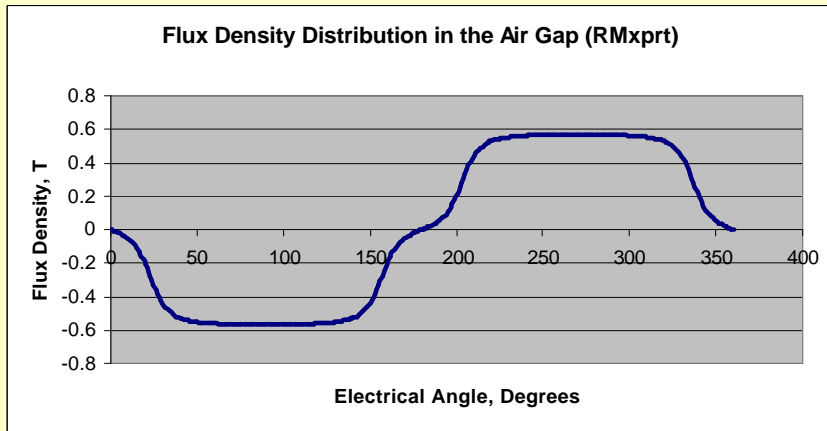

FEA shows higher flux density in the air-gap than RMxprt



# The RMxprt Analytical Design Output (cont'd)

Glenn Research Center

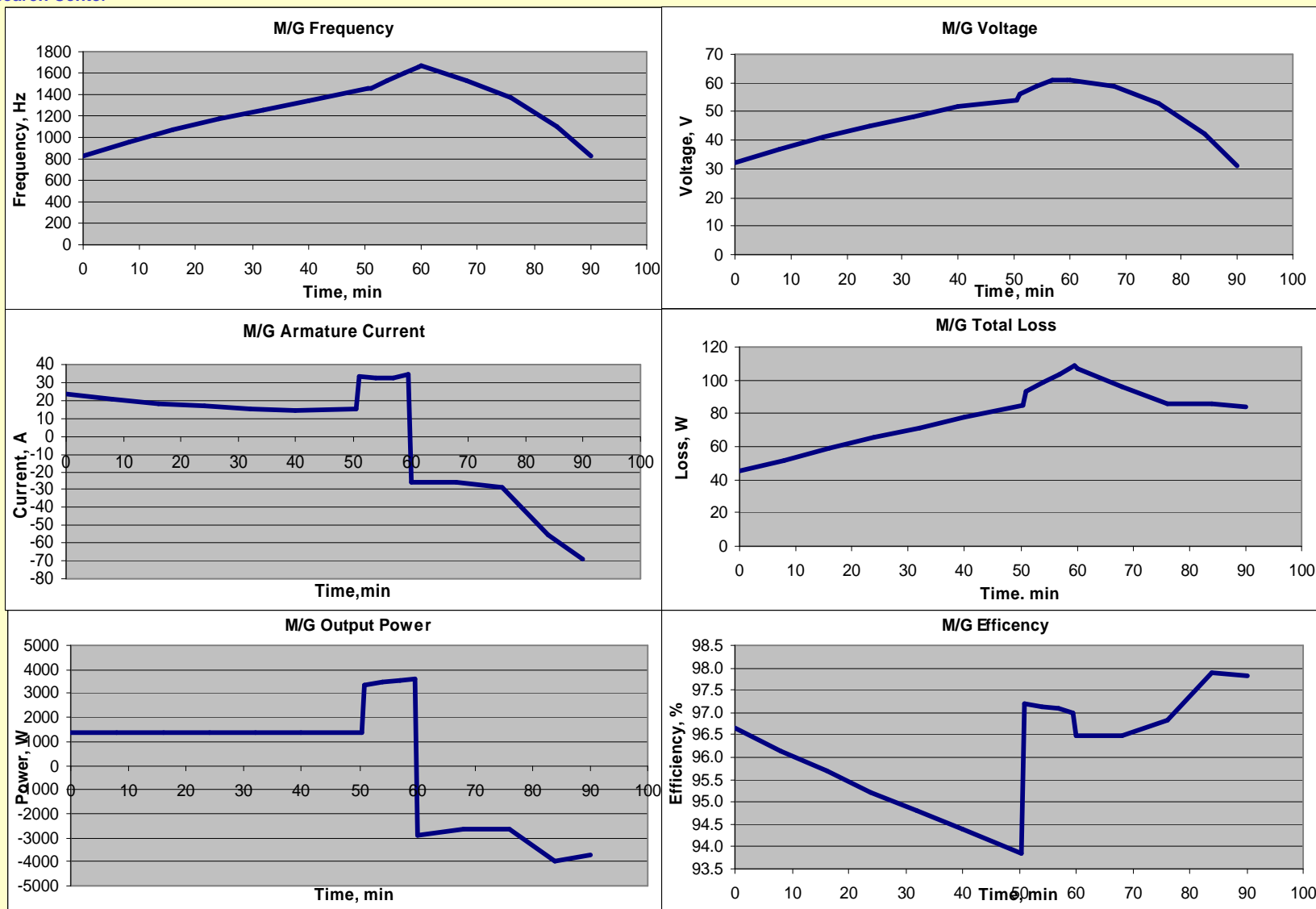

Study of M/G Characteristics During the Duty Cycle



Glenn Research Center

# Armature Reaction and Demagnetization Calculation

$$Br_t = Br_s \left[ 1 + \frac{a_{Br}}{100} (J_t - J_s) \right]$$

$$Hc_t = Hc_s \left[ 1 + \frac{a_{Hc}}{100} (J_t - J_s) \right]$$

Samarium Cobalt (Sintered) S2769 Demagnetization Lines at Different Temperatures

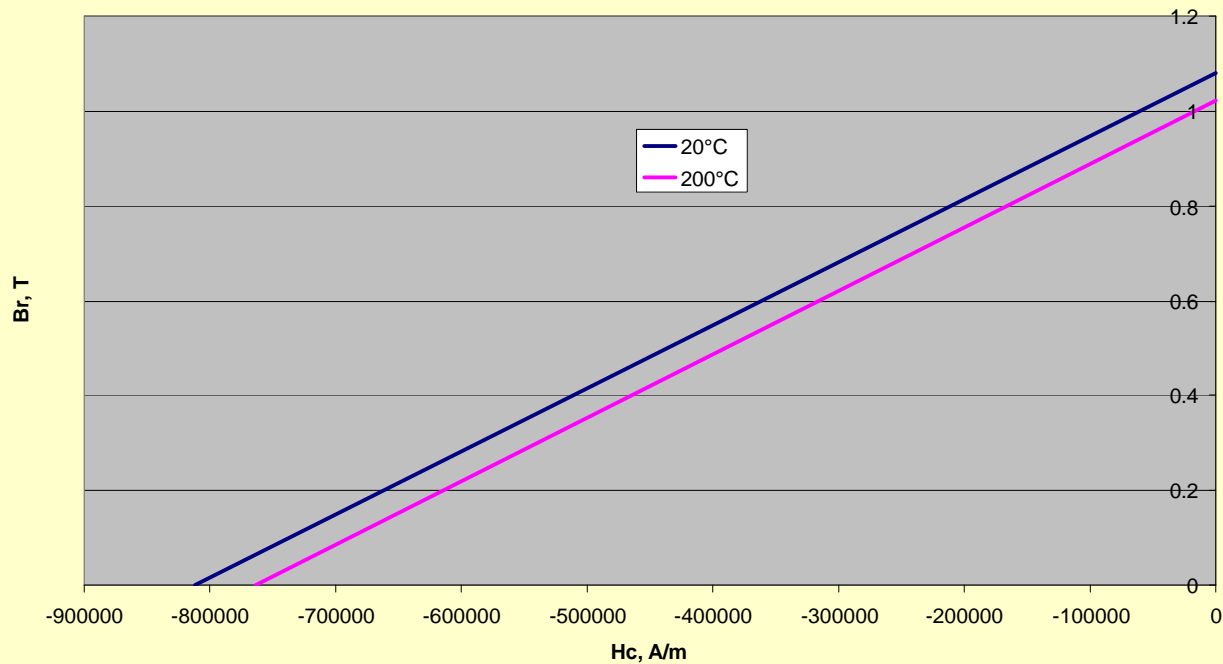

- Permanent magnet demagnetization curves are sensitive to the temperature



# Armature Reaction and Demagnetization Calculation (cont'd)

- The common method to check the demagnetization of the permanent magnets due to the armature reaction is described in T.J. Miller's book [1]. The disadvantage of this method is the assumption that the permanent magnet pole has uniform saturation.

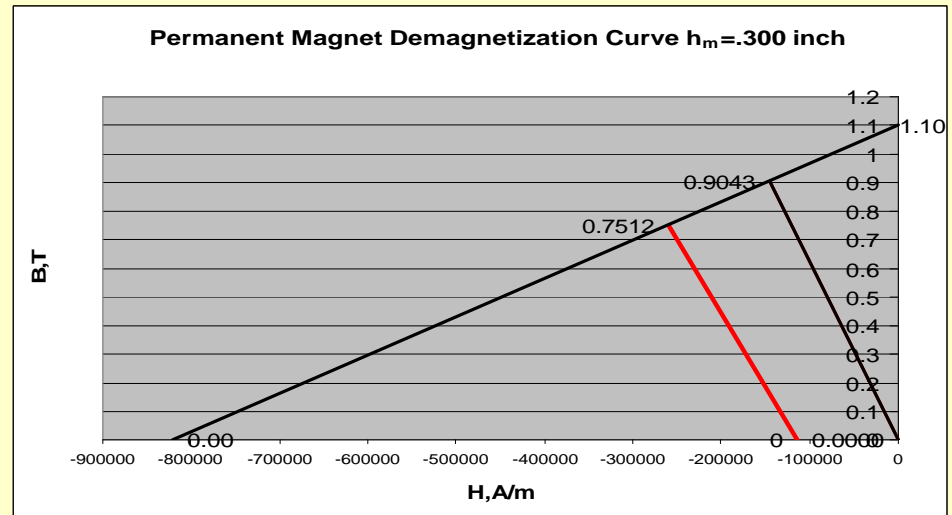
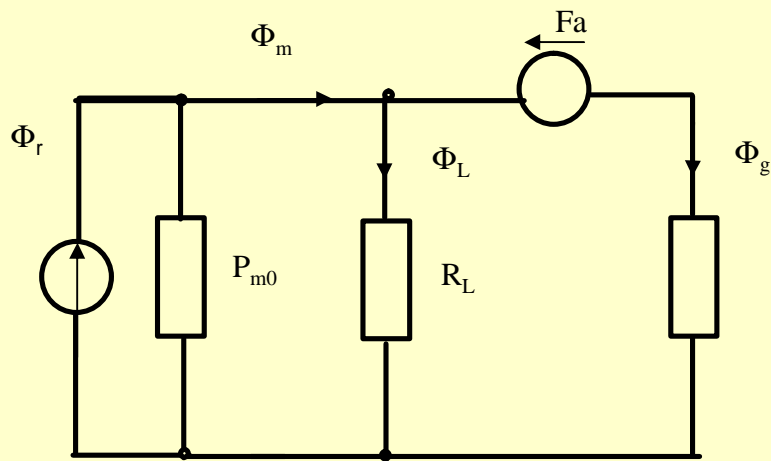

$$\Phi_r = B_r A_M \quad R_g = \frac{g'}{\mu_0 A_g} \quad B_m = \frac{1 + P_{r1} R_g}{(1 + P_m R_g)} B_r \quad B_g = \frac{C_\Phi}{(1 + P_m R_g)} B_r \quad C_\Phi = \frac{A_m}{A_g}$$

$$PC = \mu_{rec} \frac{1 + P_{r1} R_g}{P_{m0} R_g} \quad B_{ma} = \frac{\mu_0 \mu_{rec} F_{dem}}{l_m} \quad B_{load} = B_m - B_{ma} \quad -H_m = \frac{B_r - B_m}{\mu_0 \mu_{rec}} \quad P_{m0} = \frac{\mu_0 \mu_{rec} A_m}{l_m}$$



Glenn Research Center

## Armature Reaction and Demagnetization Calculation (cont'd)

A more accurate way to check the demagnetization is FEA.

- Using Maxwell 2D Transient solver, the solution for the rated load should be determined. The relative rotor-stator position and instantaneous values of the phase currents are determined.
- Then, using position and values obtained by transient solver, the Maxwell 2D Magnetostatic model can be created and the flux density distribution in permanent magnets can be determined.



Glenn Research Center

# Armature Reaction and Demagnetization Calculation (cont'd)

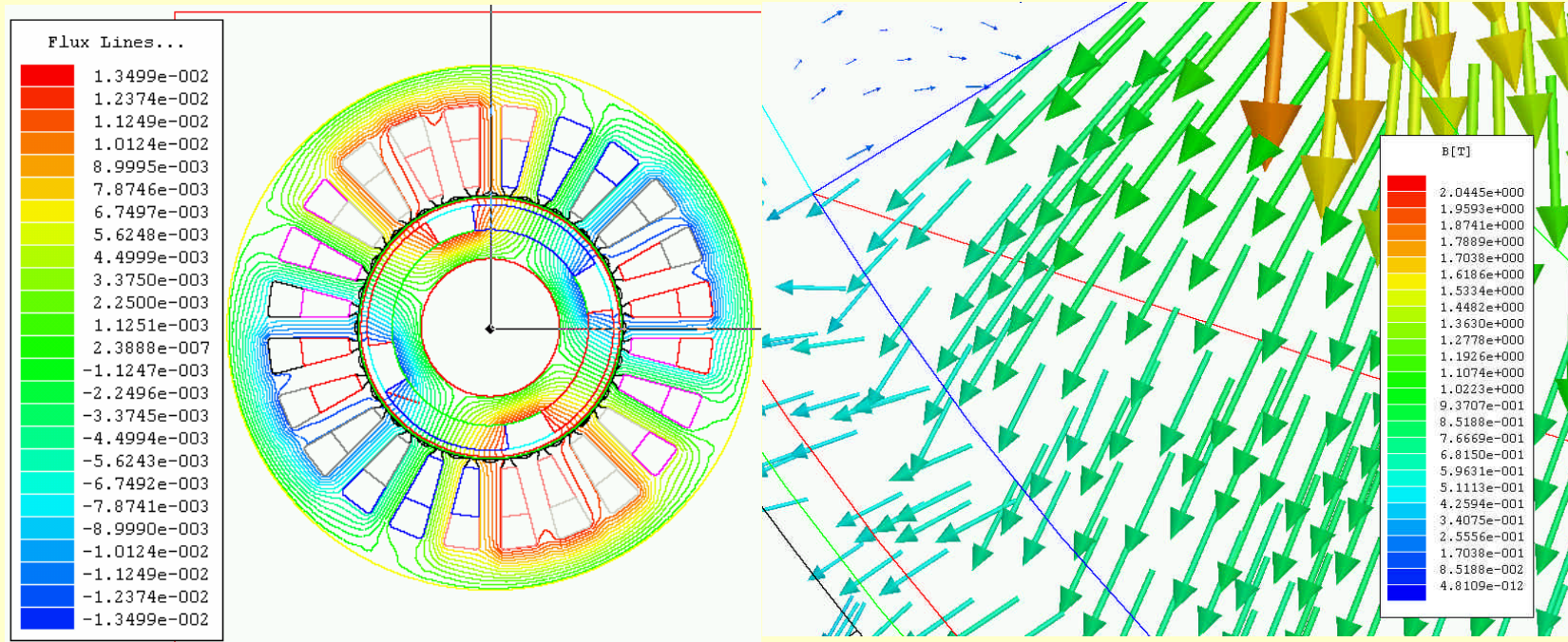

Flux lines in the motor and flux density vectors without armature reaction  
 $I_a=0$



Glenn Research Center

# Armature Reaction and Demagnetization Calculation (cont'd)

$I_a = 387 \text{ A}$

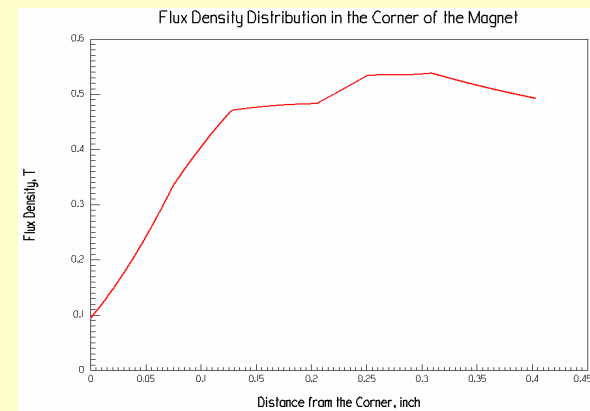
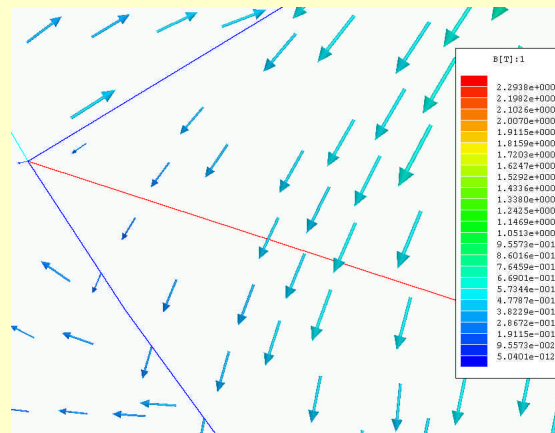
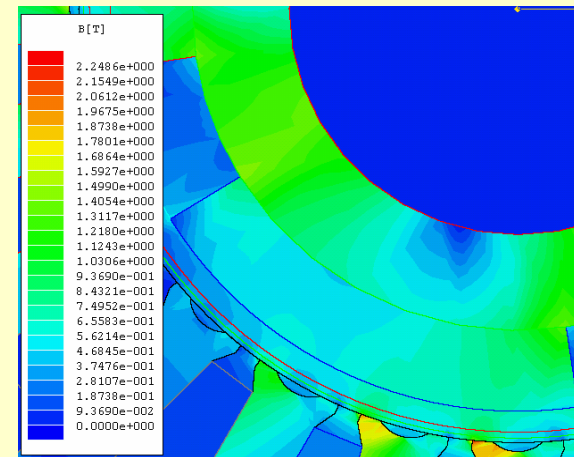
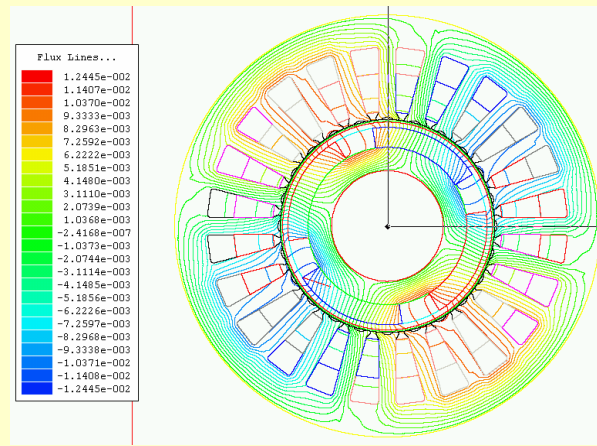

Due to the armature reaction the level of demagnetization in the corner of the magnet pole is higher than in the other areas of the magnet



Glenn Research Center

# Armature Reaction and Demagnetization Calculation (cont'd)

$I_a=581A$

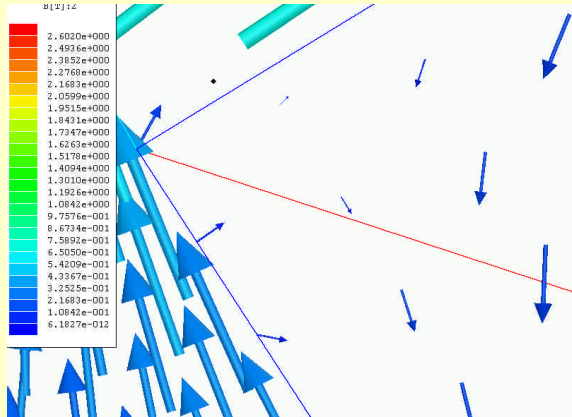

Flux Intensity distribution in the corner of the magnet

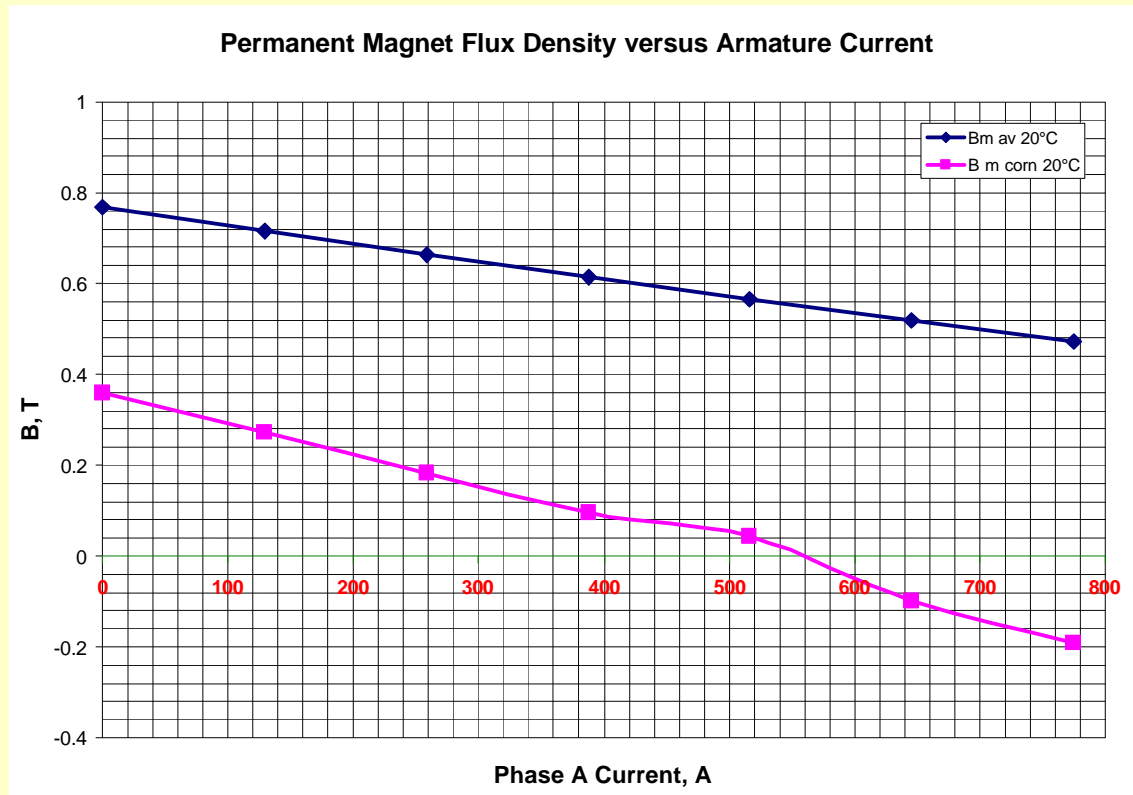
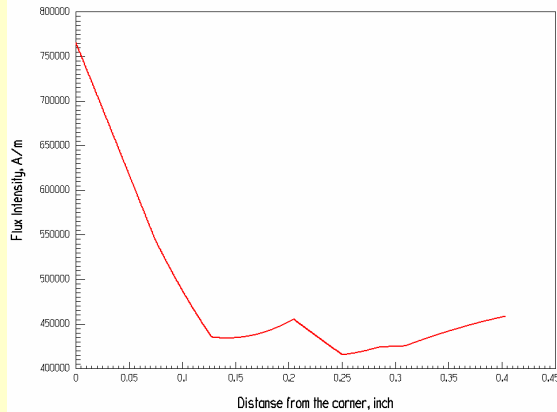

The average value of flux density in the magnet is still much more than zero, but the corner area of the magnet is demagnetized





Glenn Research Center

## M/G 2D Finite Element Modeling

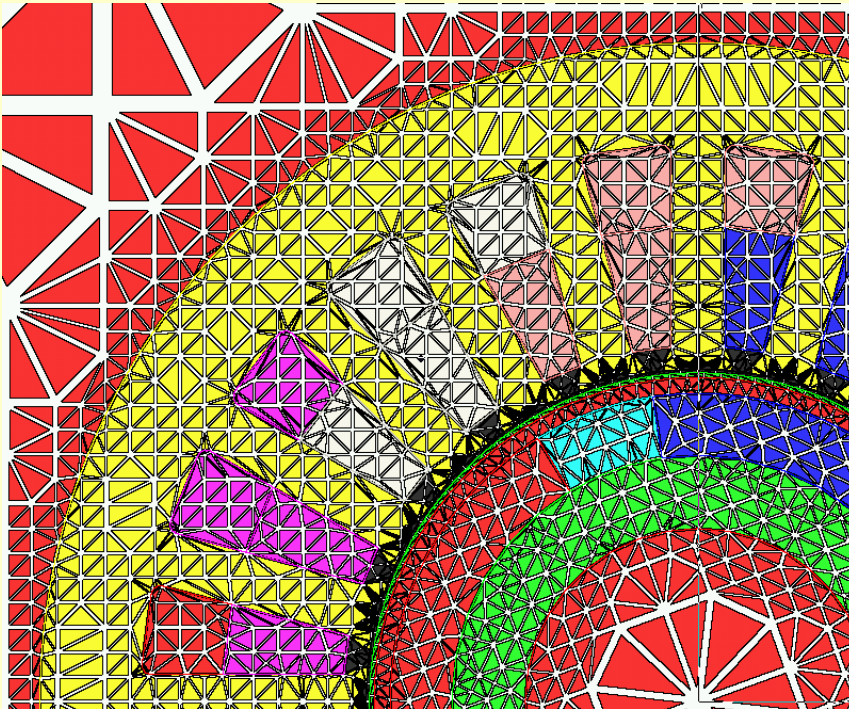

- A more accurate solution of M/G characteristics can be found by using finite element analysis. Thus, the accuracy of the results obtained by RMxpert software could be verified.
- The transient finite element model includes a rotor and stator core, conductors, shaft, magnets, spacers between magnets and a carbon fiber ring. Thus, all components of the rotor losses can be determined with a good accuracy.



Glenn Research Center

## M/G 2D Finite Element Modeling (cont'd)

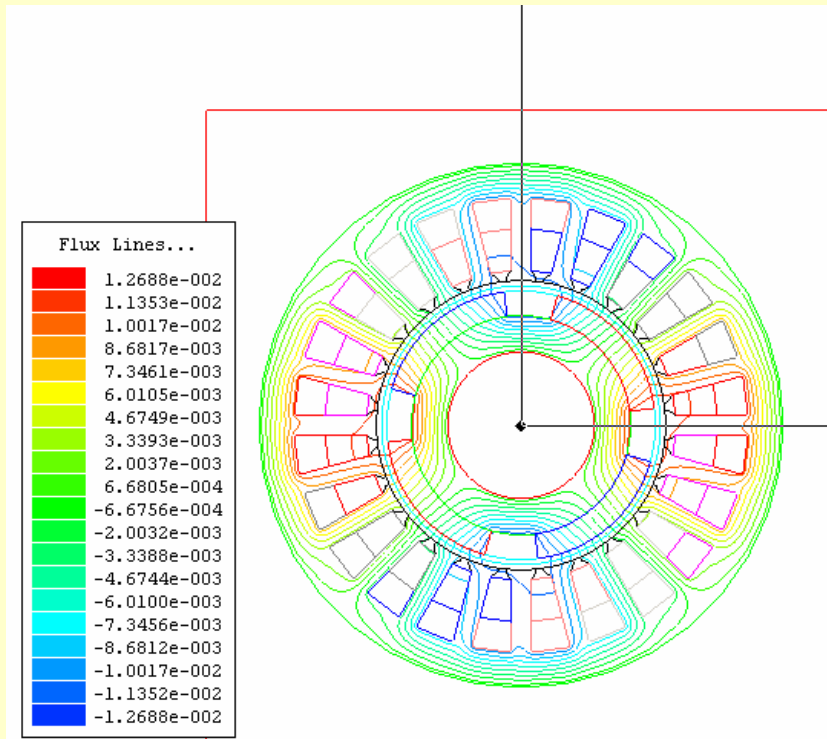

- Maxwell 2D transient mode solver with the time-stepping approach was employed.

The effects of saturation, eddy currents, slotting, rotor position and space harmonics are taken into account.

Because of using two-layer short pitched winding, where two layers of the winding have the angular displacement, there is no mirror symmetry in this machine. Thus there was no opportunity to use the master slave symmetry

- Two different approaches were applied to investigate the M/G characteristics: sinusoidal voltage sources and sinusoidal current sources. Both techniques show similar results for the motor characteristics.
- After transient solution the Magnetostatic solver was used to check the value of the torque, developed for the specified current values.



# M/G 2D Finite Element Modeling (cont'd)

Glenn Research Center

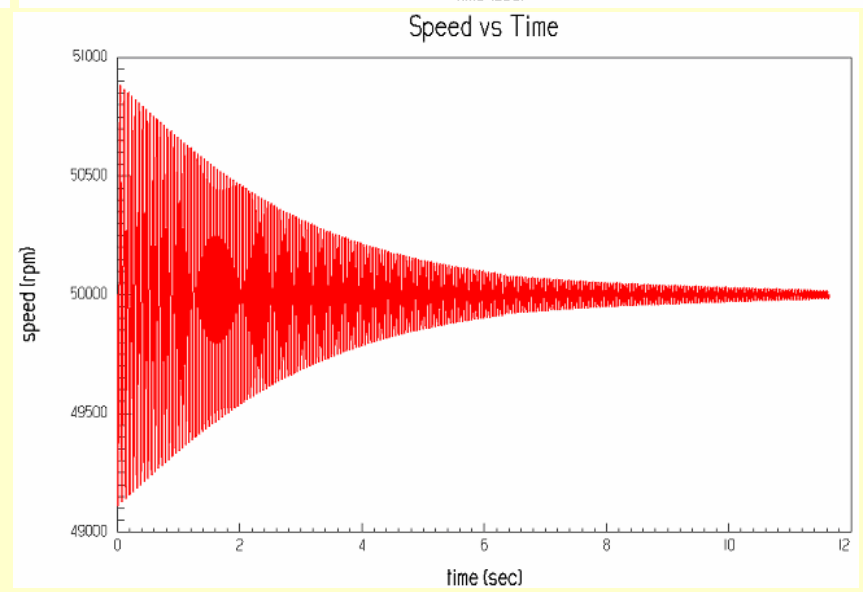
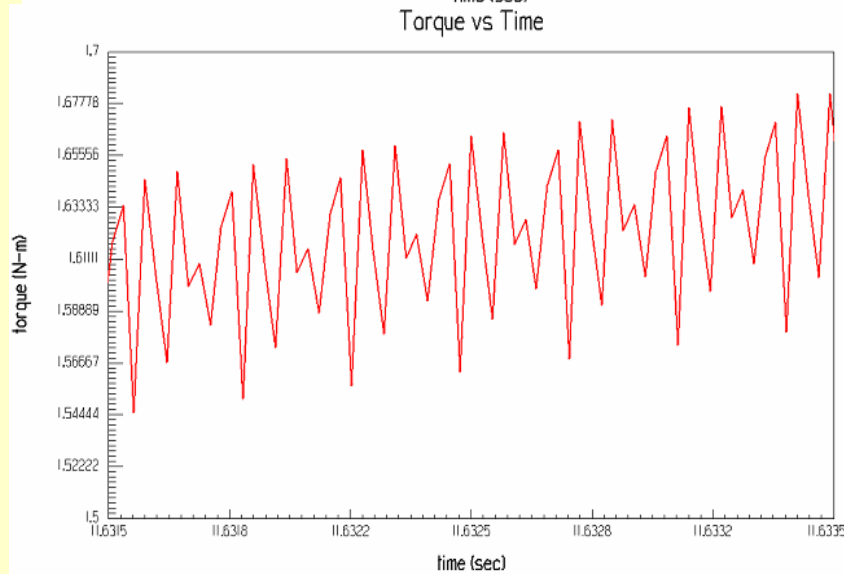
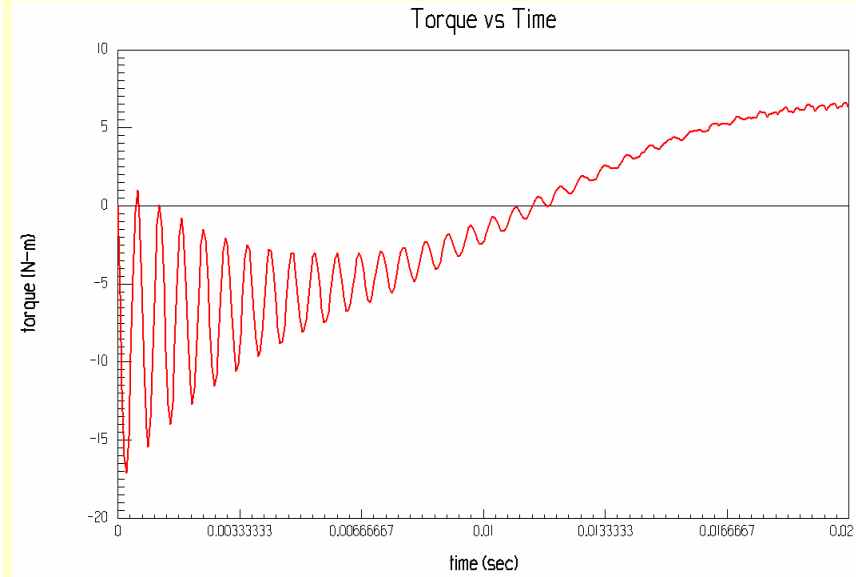
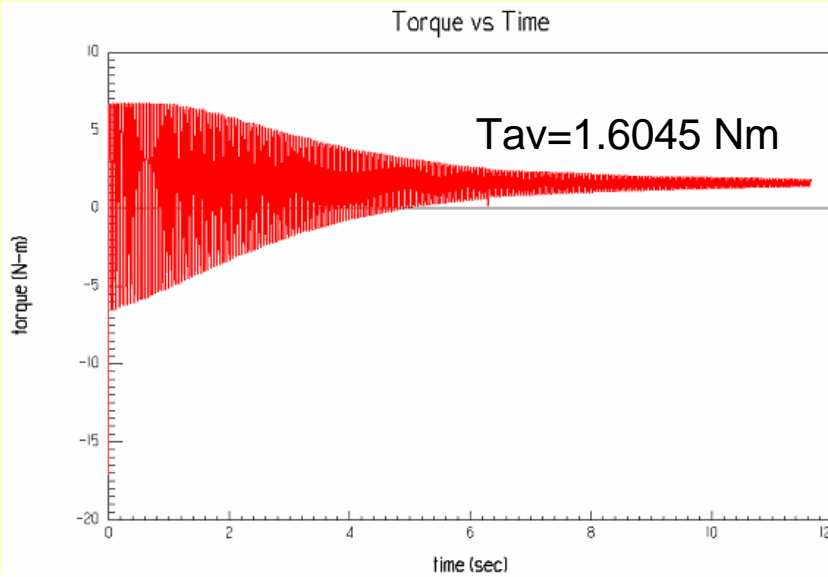



Glenn Research Center

## M/G 2D Finite Element Modeling (cont'd)

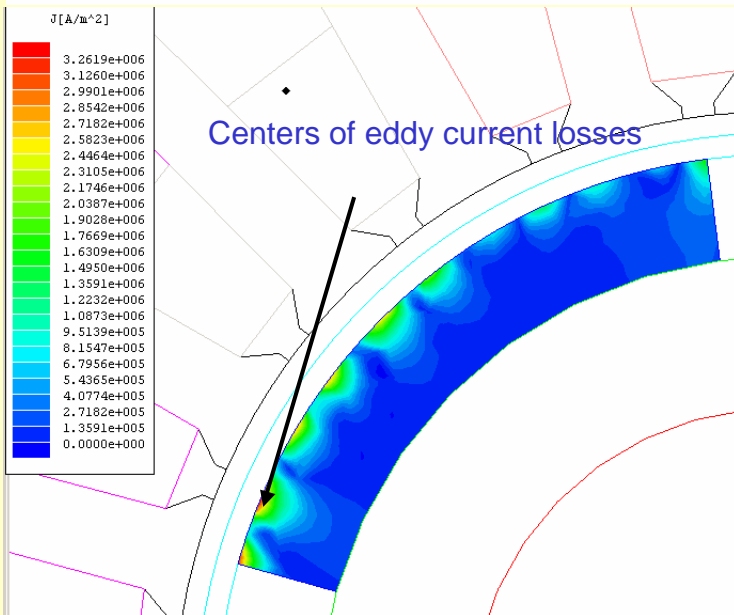
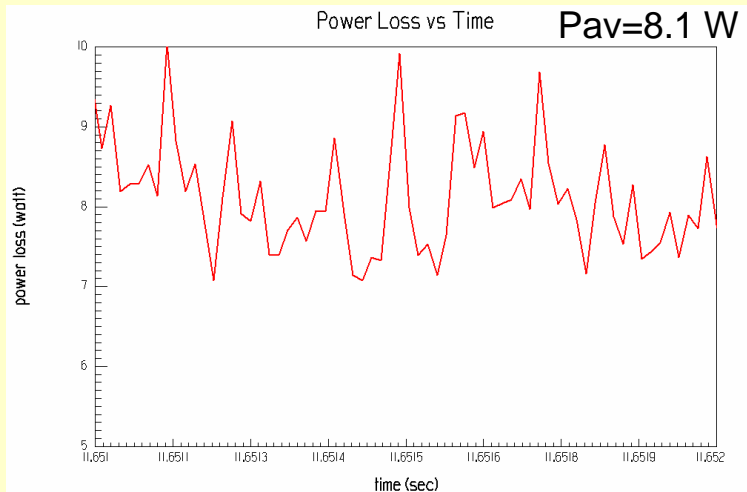

Eddy current losses were calculated for permanent magnets, carbon fiber ring and spacers between magnets.

$$P = l \frac{1}{\sigma} \int_A J \cdot J dA$$

Where  $\sigma$  is the conductivity of material,  $l$  is the depth of an eddy current loop in Z direction,  $A$  is the surface area,  $J$  is a current density.

Could be noticed, that the peaks of eddy current losses are located under slot openings. The value of local eddy current density depends on instantaneous value of the current in the closest slot.



## M/G 3D Finite Element Modeling

The stator slot skewing causes a force in axial direction, that can affect the operation of magnetic bearings. The following technique was employed to determine the value of this force.

- 1) From Maxwell 2D Transient solver, the relative rotor-stator position and instantaneous values of phase currents are found.
- 2) Using these position and currents values the Maxwell 3D Magnetostatic model was created and the force values versus phase currents were determined, taking effect of skewing into account.

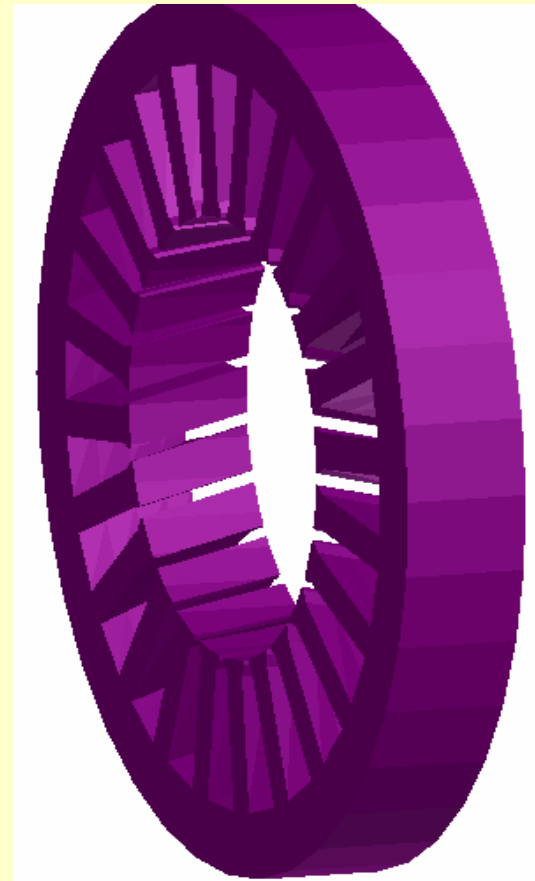



Glenn Research Center

# M/G 3D Finite Element Modeling (cont'd)

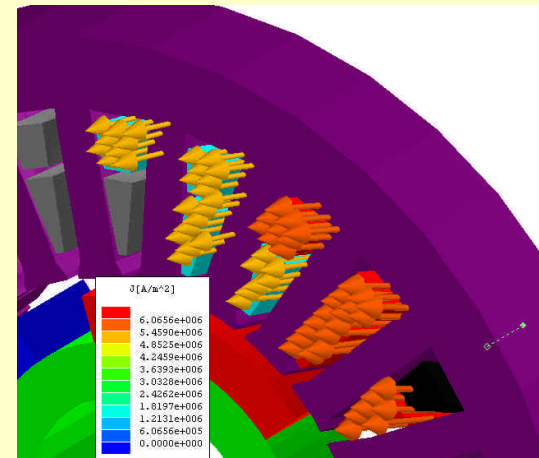
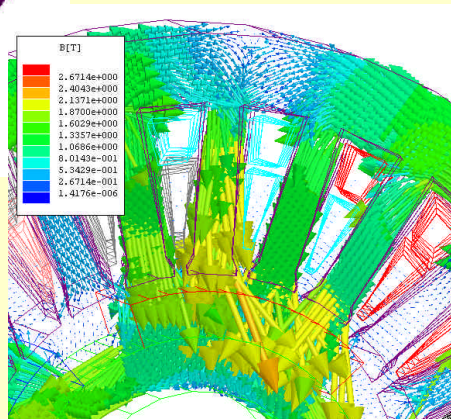
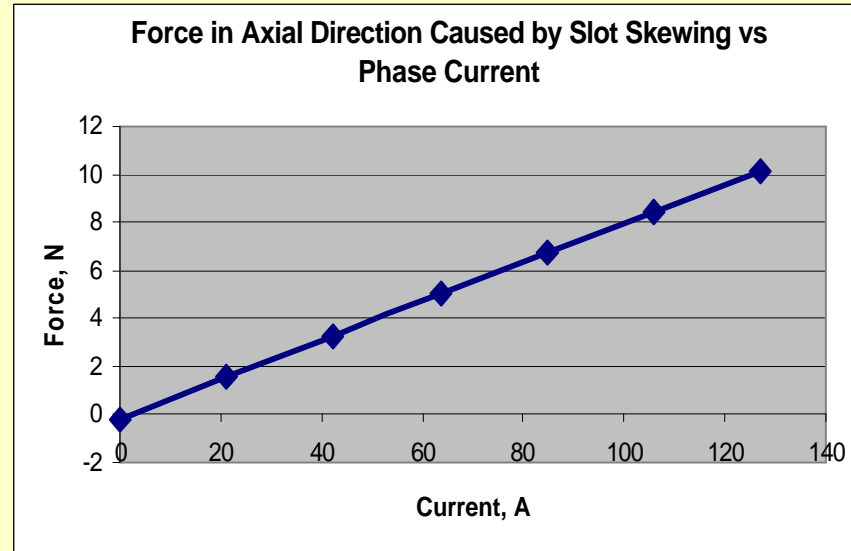
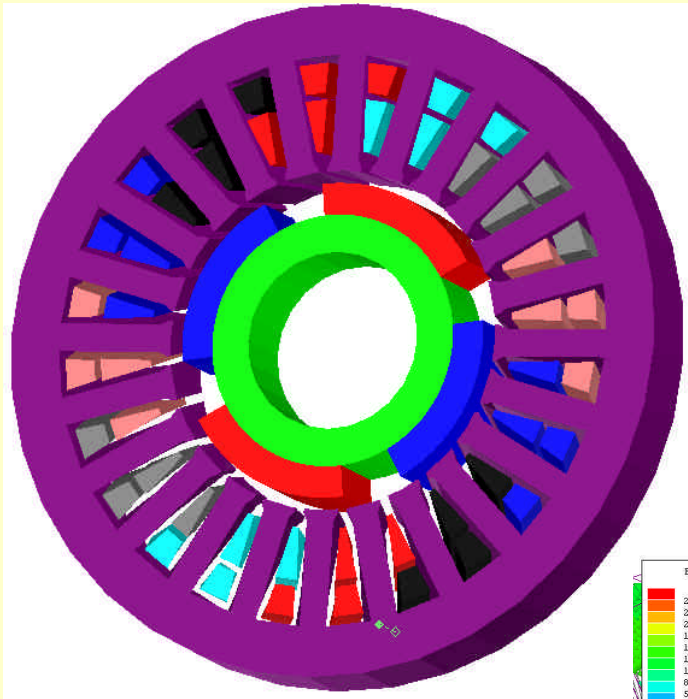

3D model takes 2 layer winding and slot skewing into account



Glenn Research Center

## G3 Flywheel M/G Design

Based on the design results presented, M/G as a part of new flywheel G3 module was fully designed and the prototype is planned to be fabricated this year.

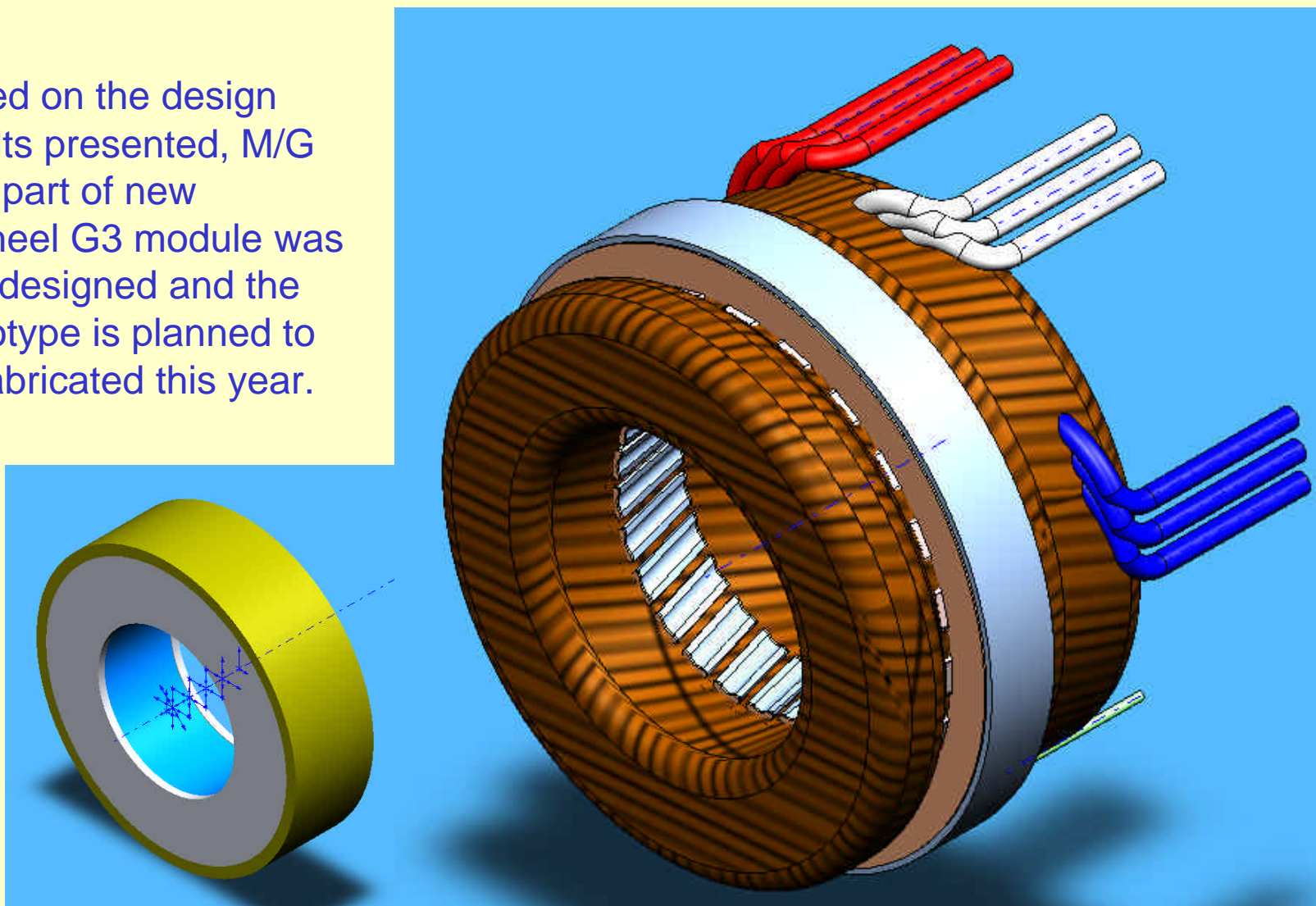



## Concluding Observations and Recommendations

- Ansoft RMxpert, Maxwell 2D and 3D are powerful tools for electrical machine design.
- Some suggestions to make the use of these programs more convenient are given below
  1. It would be useful as a part of the RMxpert outputs for the synchronous PM motors and generators to show the demagnetizing curve of the magnets (with the load and no-load lines), the energy product line, and the phasor diagram of the rated point of the machine.
  2. The simulation of high frequency synchronous PM machine in transient mode requires relatively small time steps. Because of this it takes a lot of computing time to get steady state results for the transient analysis in 2D and especially in a 3D simulation.





Glenn Research Center

# References

1. J. R., Jr Hendershot, T. J. E. Miller, "Design of brushless permanent-magnet motors," Oxford University Press, 1996



Glenn Research Center

# Acknowledgements

This work was performed while the author held a National Research Council Associateship Award at NASA Glenn Research Center Cleveland Ohio